

Gear Generator and Content Center

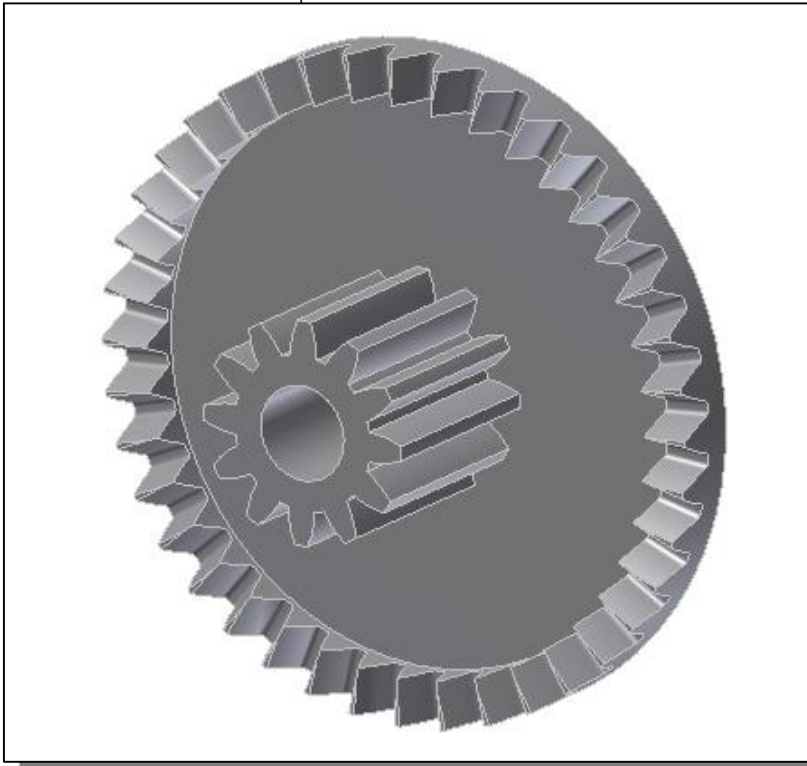

Learning Objectives

- ◆ Understand the Gear Nomenclatures
- ◆ Use the Autodesk Inventor Design Accelerator
- ◆ Use the Spur Gear Component Generator
- ◆ Use the Autodesk Content Center Libraries

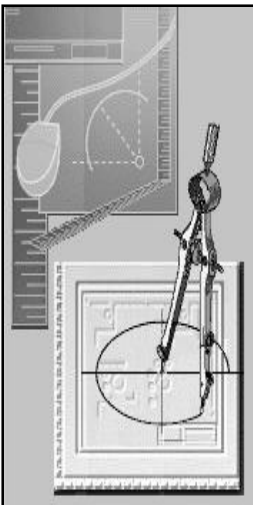

Introduction to Gears

A **gear** is a rotating machine part having cut *teeth*, which *mesh* with another toothed part in order to transmit mechanical motion and power. Gears are very versatile machine elements; they range in size and use from tiny gears in watches to large driving gears in punch presses. Geared devices can be used to change the speed, torque, and direction of a power source. The most common situation is for a gear to mesh with another gear having parallel shaft axes; however a gear can also mesh with another toothed part in a way to produce motion in a nonparallel axis direction. The more commonly used types of gears include the **Spur Gear**, the **Bevel Gear**, the **Helical Gear**, the **Worm Gear** and the **Rack and Pinion**.



Rack and Pinion

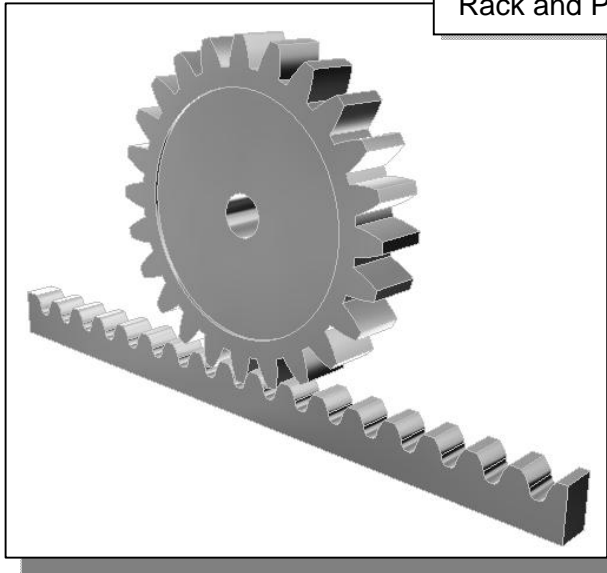

Internal Gears

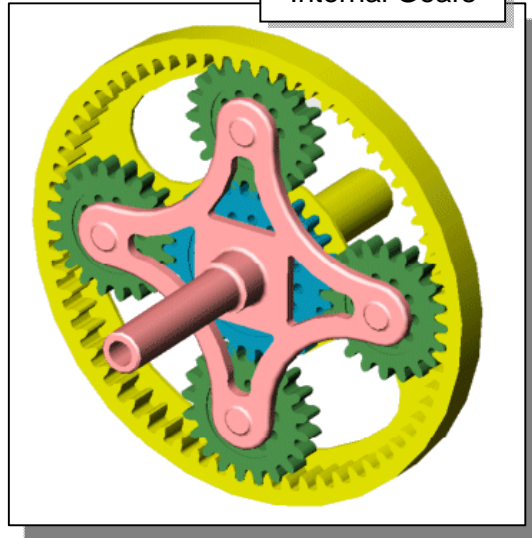

Transmission

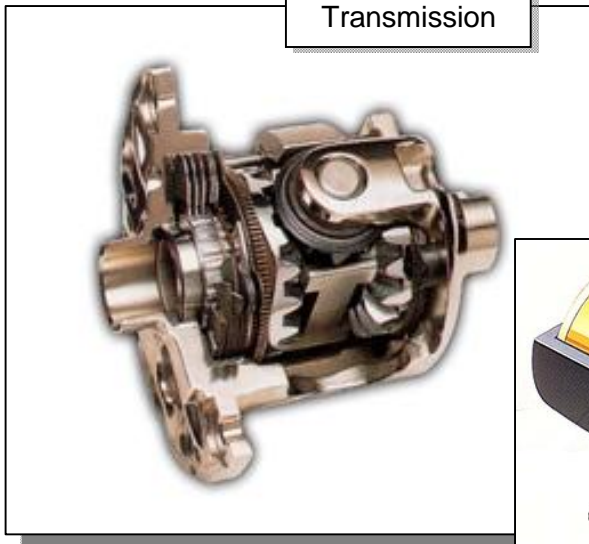

Gearbox

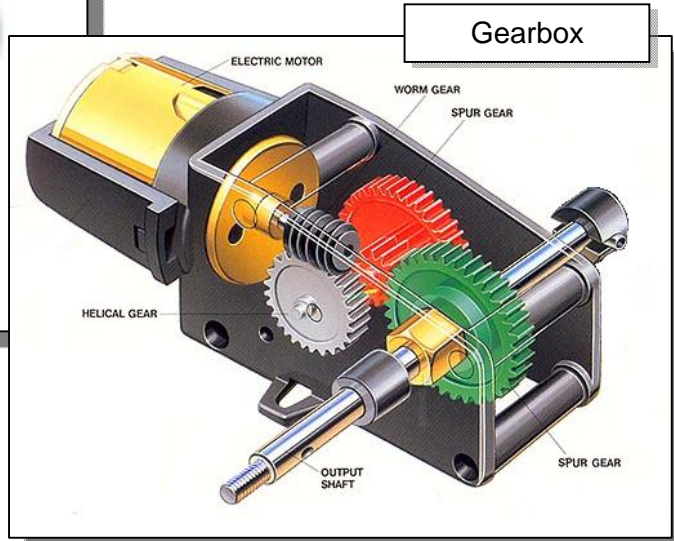

Two or more gears working in tandem are called a *gear train* and can produce a mechanical advantage through a designed gear ratio. For gears to function properly, they must fulfill the following basic requirements: (1) Transmit motion smoothly and efficiently; (2) Maintain fixed angular relationships between members; (3) Must be interchangeable with other gears having the same tooth size.

Spur Gear Nomenclatures

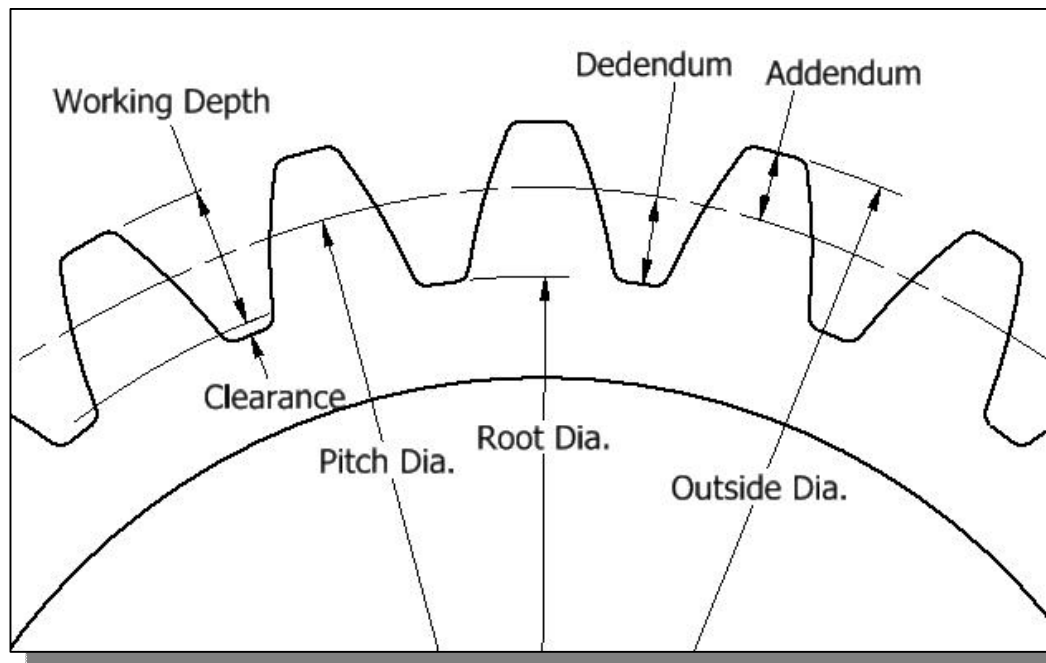

Outside diameter (Addendum diameter)

Diameter of gear blank, measured prior to cutting the teeth.

Root diameter

Diameter of the gear, measured across the bottom of the teeth.

Pitch diameter

Diameter of the pitch circle; the standard pitch diameter is a basic dimension at which the thread tooth and the thread space are equal. The circular tooth thickness, pressure angle and helix angles are all defined at the pitch circle.

Addendum

The top portion of the gear tooth; it is measured from the pitch circle to the outermost point of the tooth.

Dedendum

The bottom portion of the gear tooth; it is measured from the root circle to the pitch circle.

Clearance

Distance between the root circle of a gear and the addendum circle of its mate.

Working depth

Depth of engagement of two gears, that is, the sum of their operating addendums.

Whole depth

The distance from the top of the tooth to the root; it is equal to addendum plus dedendum or to working depth plus clearance.

Circular Pitch

Circular pitch is the distance measured along the pitch circle, from a point on one tooth to the corresponding point on the adjacent tooth.

$$\text{Circular Pitch} = \text{Pitch diameter} / \text{No. of teeth}$$

Pitch, Diametral Pitch

Diametral pitch of a gear is an expression of tooth size. It is the *number of teeth per inch of pitch diameter*. Thus, a gear with a 2-in. pitch diameter and 40 teeth is a 20-pitch gear. Any two gears having the same pitch will operate together, provided they are based on the same gear system.

$$\text{Diametral Pitch} = \text{No. of teeth} / \text{Pitch diameter} = 40/2 = 20\text{-Pitch}$$

Module

A scaling factor used in **metric** gears with units in millimeters whose effect is to enlarge the gear tooth size as the module increases and reduce the size as the module decreases.

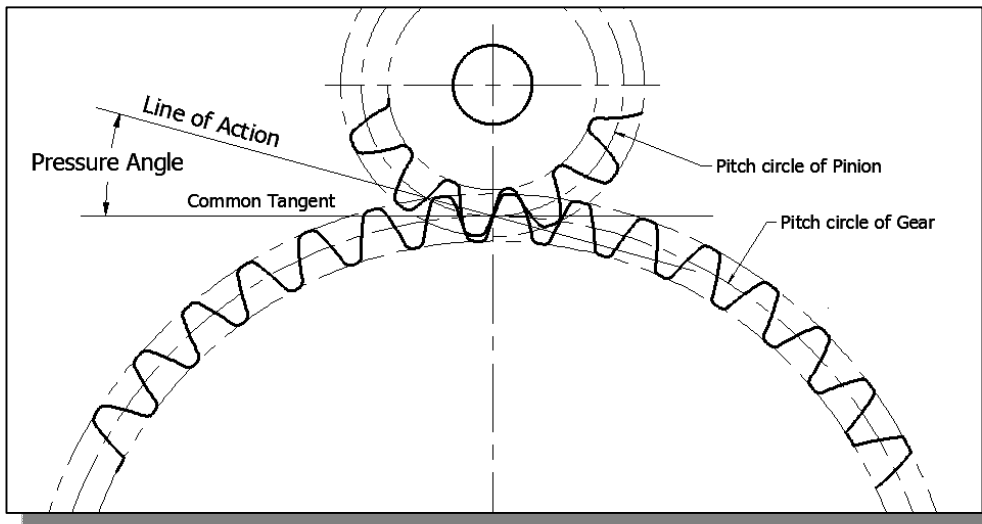

Gear: The larger of two interacting gears or a gear on its own.

Pinion: The smaller of two interacting gears.

Pitch point: Point where the line of action crosses a line joining the two gear axes.

Line of action, pressure line

Line of action is the line along which the force between two meshing gear teeth is directed. In general, the line of action changes from moment to moment during the period of engagement of a pair of teeth. For involute gears, however, the tooth-to-tooth force is always directed along the same line.

Pressure angle

The angle formed between the direction of the teeth exerting force on each other, and the common tangent line of the two pitch circles of the two gears. For involute gears, the teeth always exert force along the line of action, which, for involute gears, is a straight line; and thus, for involute gears, the pressure angle is constant.

Starting Autodesk Inventor

1. Select the **Autodesk Inventor** option on the *Start* menu or select the **Autodesk Inventor** icon on the desktop to start *Autodesk Inventor*. The *Autodesk Inventor* main window will appear on the screen.

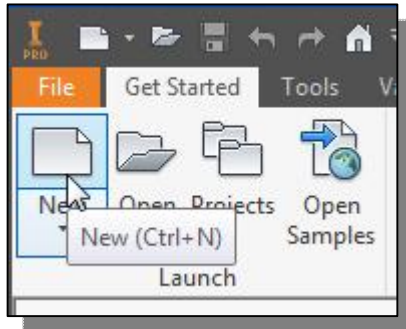

2. Select the **New File** icon with a single click of the left-mouse-button in the *Launch* toolbar as shown.

3. Select the **Metric** tab and in the *Template* list, then select **Standard(mm).iam** (*Standard Inventor Assembly Model* template file).

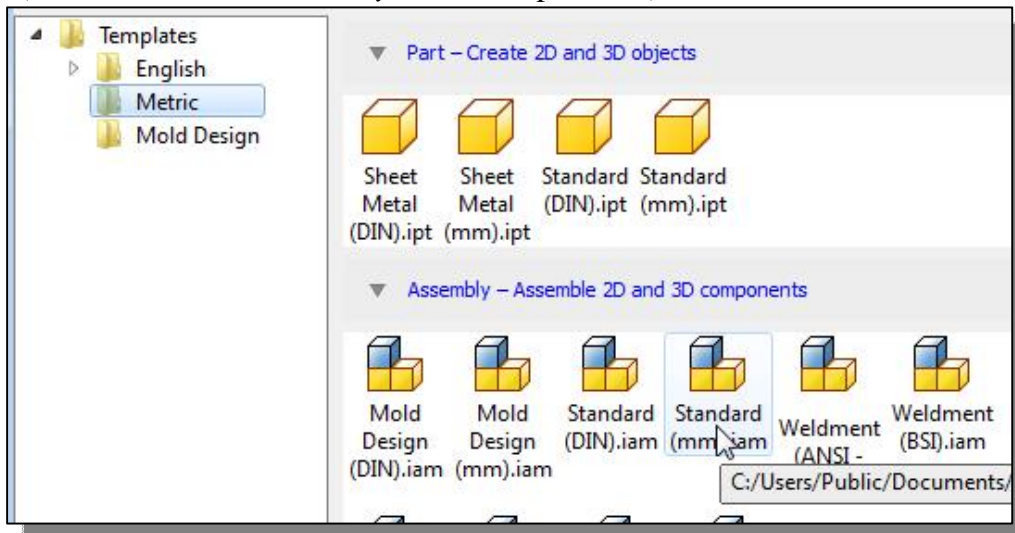

4. Click on the **Create** button in the *New File* dialog box to accept the selected settings and start a new assembly model.

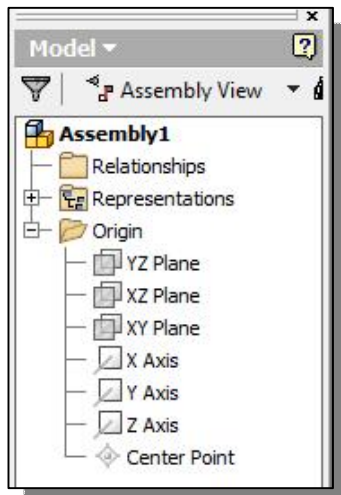

In the *browser* window, **Assembly1** is displayed with a set of work planes, work axes and a work point. In most aspects, the usage of work planes, work axes and work point is very similar to that of the *Inventor Part Modeler*.

Notice in the *Ribbon* toolbar panels, several *component* options are available, such as **Place Component**, **Create Component** and **Place from Content Center**. As the names imply, we can use parts that have been created or create new parts within the *Inventor Assembly Modeler*.

The *Inventor* Spur Gear Generator

In this section, we will illustrate the procedures to create gears with the **Spur Gear** component generator. Note that the nylon gears in the *Tamiya Tiger kit* are specifically designed for the *Tamiya kits*, and therefore the tooth profiles do not match with the gear profiles generated using the *Inventor Design Accelerator*.

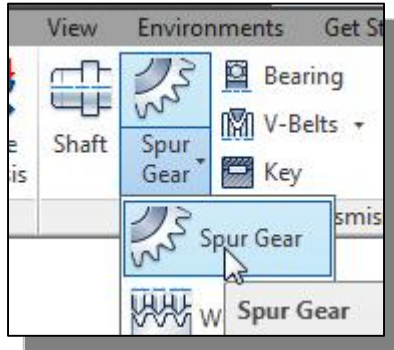

1. In the *Design* tab of the Ribbon toolbar area, select the **Spur Gear** command by left-clicking the icon.

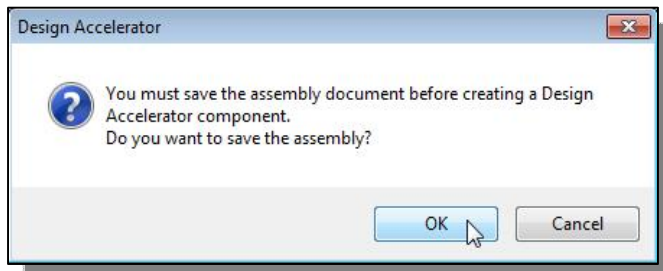

2. Click **OK** to save the current assembly

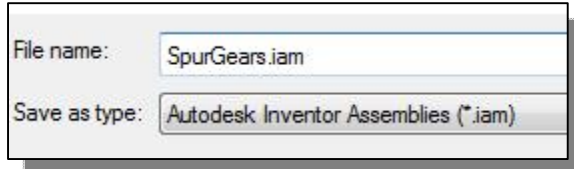

3. Enter **SpurGears** as the assembly model name.

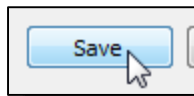

4. Click on the **Save** button to save the model file.

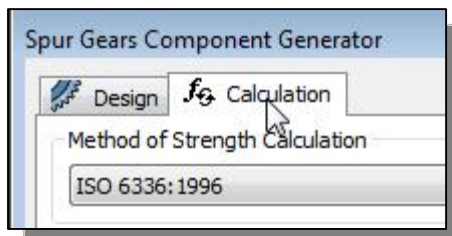

5. Click on the **Calculation** tab to set the associated power rating of the system.

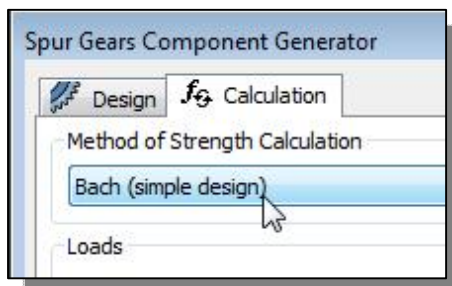

6. Choose **Bach (simple design)** as the method of strength calculation.

7. In the *Loads* section, set the variables using the following values: **Power** to **0.001 KW**, **Speed** to **500 rpm** and **Efficiency** to **0.90** as shown in the figure.

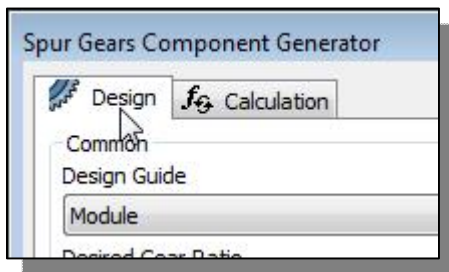
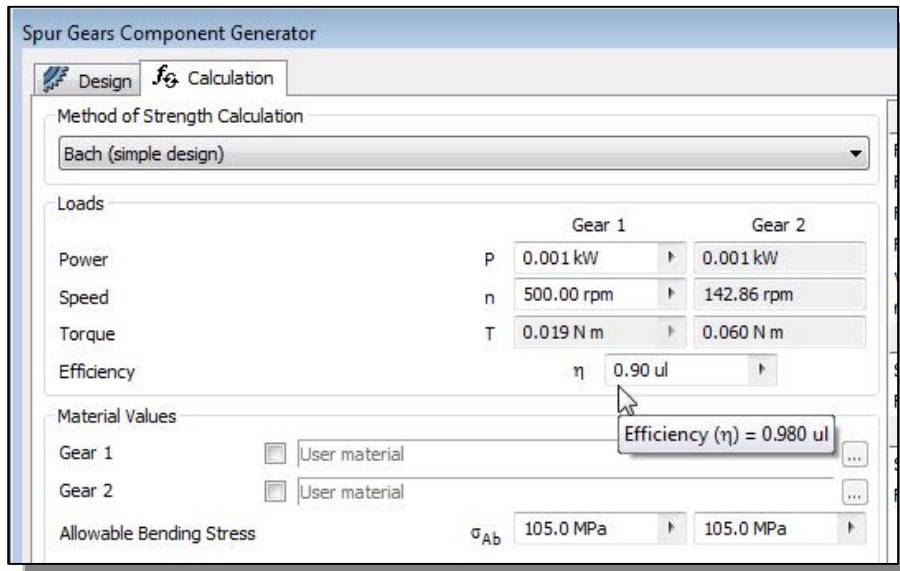

8. Click on the **Design** tab to switch back to adjust the settings of the related gears.

9. Set the *Design Guide* to use **Module** as shown.



10. Click on the [>>] button to show the additional settings.

11. Set the *Input Type* to **Number of Teeth** and *Size Type* to **Module** and *Reaching Center Distance* to **Teeth Correction**. Also set the *Unit Tooth Sizes* to the values as shown.

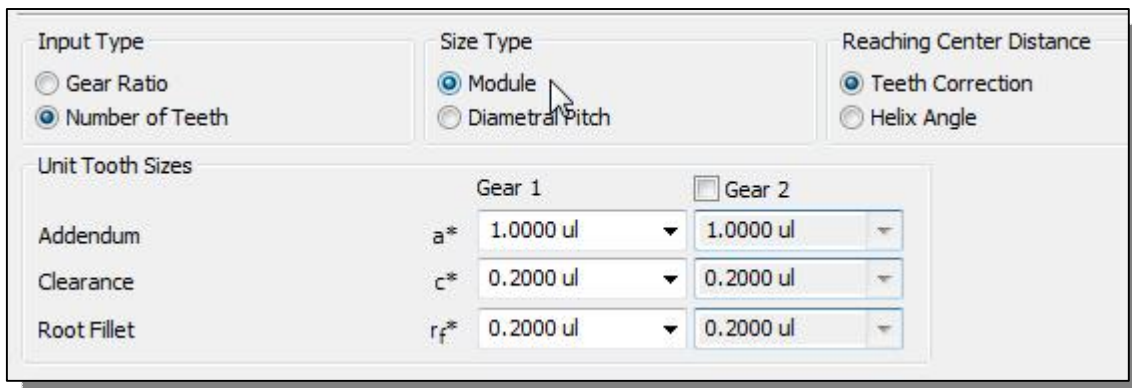

12. Set the *Design Guide* to **Module**, *Center Distance* to **13.5 mm** and *Pressure Angle* to **22.5 degrees**. Set the gear option to **Component** and enter **12** for the *Number of Teeth of Gear 1* and **42** for the *Number of Teeth of Gear 2*. Also set the *Facewidth* to **5 mm** and *Unit Correction* to **0.1**.

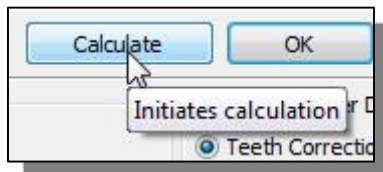
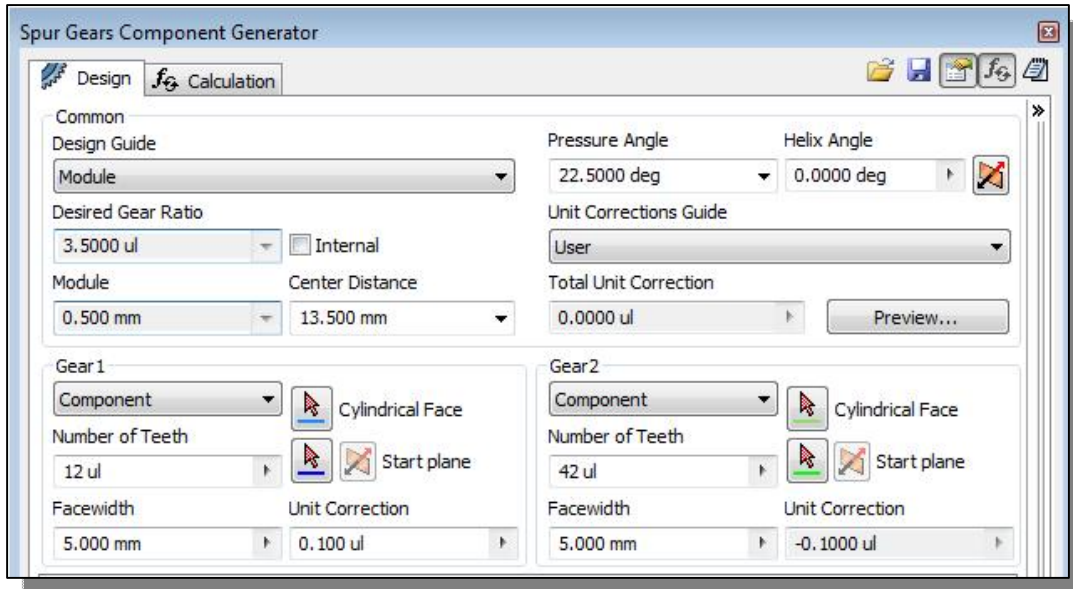

13. Click **Calculation** to initiate the necessary calculations to determine the gear profiles.

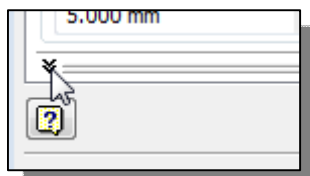

14. The results of the calculations are listed in the dialog box below, click on the small down arrow to display the dialog box.

15. In this case, *Inventor* indicated that the gears will need to be adjusted for proper operation.

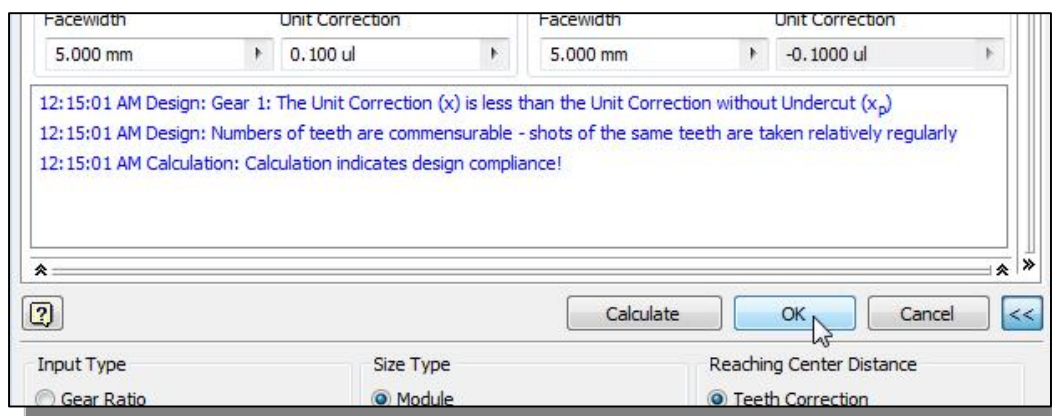

16. Click **OK** to proceed with placing the gears in the assembly model.

17. Click **OK** to accept the default naming of the files for the new gears.

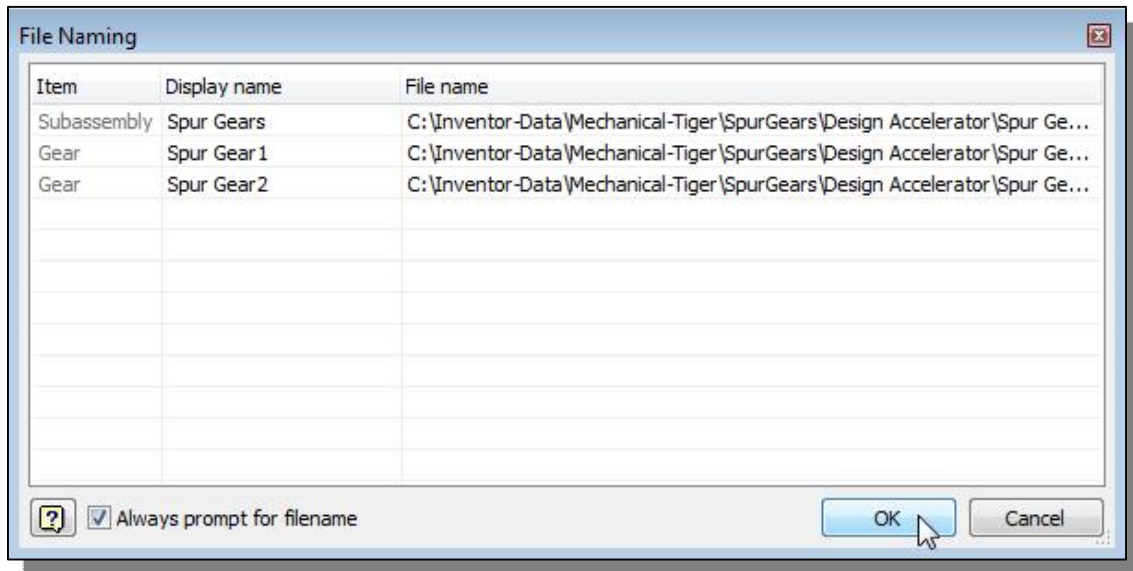

18. Place the gears in the assembly model by clicking in an empty location inside the graphics window.

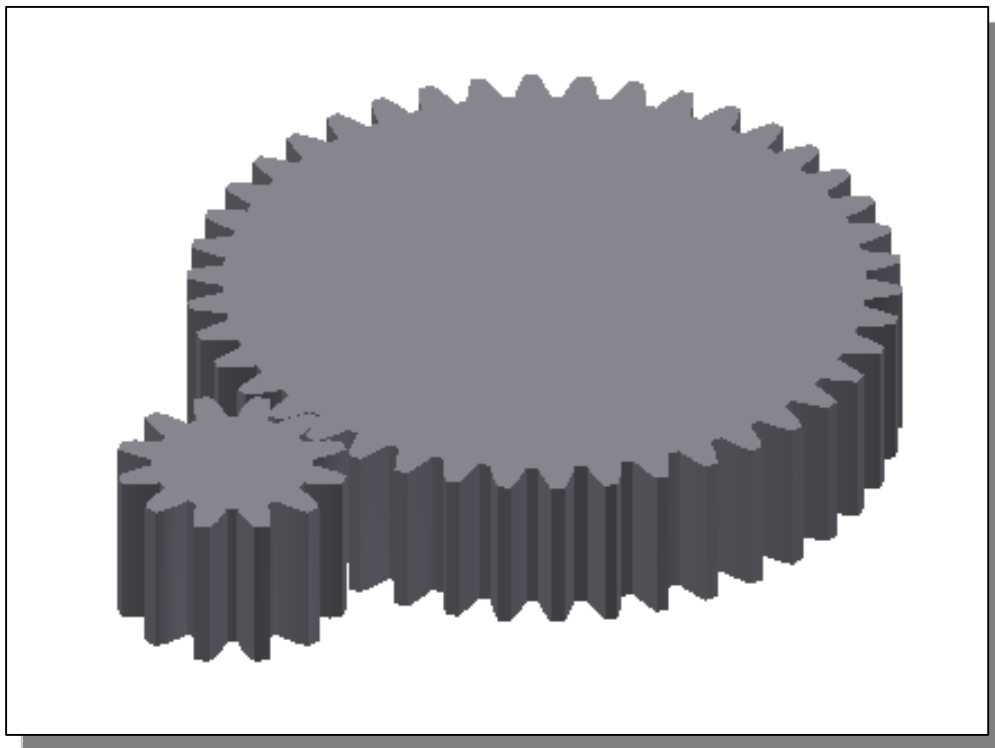

- The *Autodesk Inventor Design Accelerator* provides a convenient way to create a gear set. Note the creation of true gear tooth profiles can be very time consuming by traditional methods. The created gears can also be edited and modified just like a regular *Inventor* part.

Using the Content Center



1. In the *Assemble* panel select the **Place from Content Center** command by left-clicking the icon. Also set the **filters** option to **ISO**.

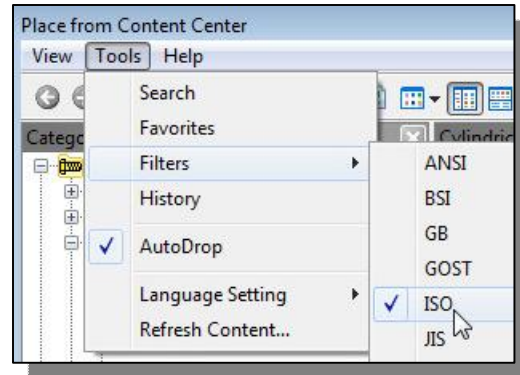

2. Select the **Fasteners** category and then **Pins** as shown.

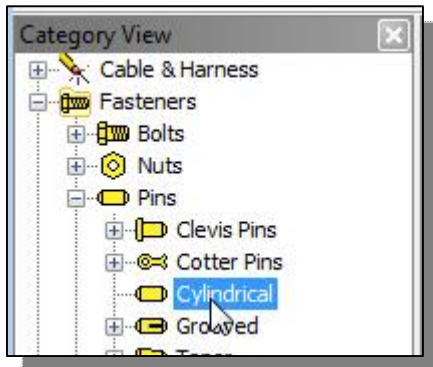
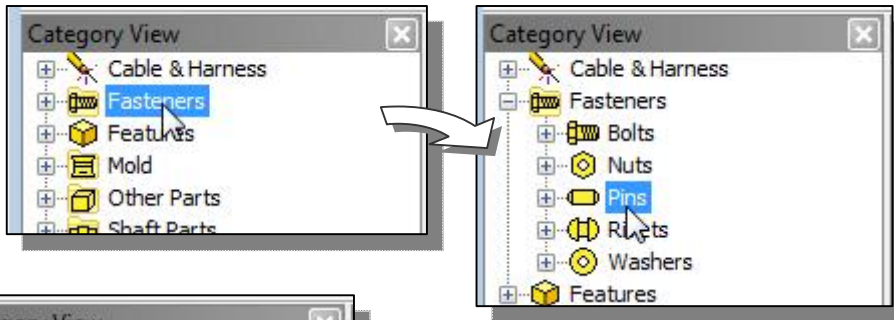

3. Choose **Cylindrical** under **Pins** as shown in the figure.

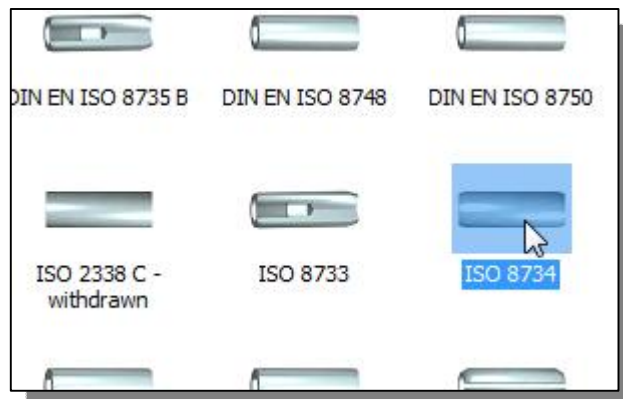

4. Select **ISO 8734** as shown in the figure.

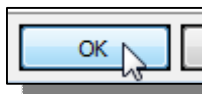

5. Click **OK** to enter the selection dialog box.

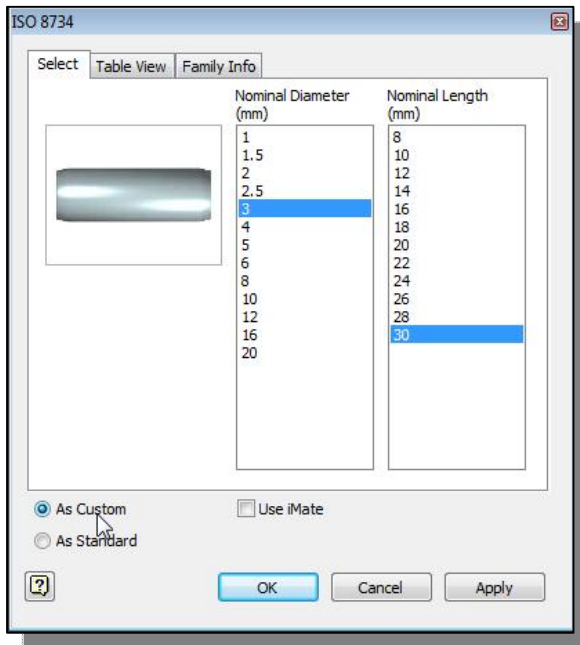

6. Set the designation diameter to **3** mm.
7. Set the nominal length to **30** mm.
8. Switch *ON* the **As Custom** option as shown.
9. Click on the **Table View** tab to view a more detailed listing of the available pins.

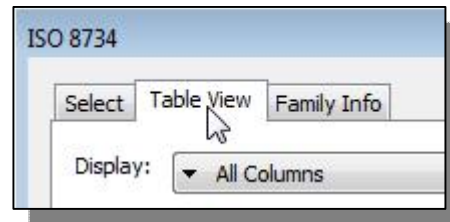

43	3	26	0.5
44	3	28	0.5
▶ 45	3	30	0.5
46	4	10	0.63
47	4	12	0.63

➤ Note the selected pin is highlighted in the list.

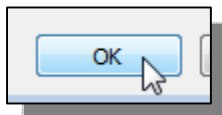

10. Click **OK** to accept the selection.

11. In the *Save As* dialog box, enter **Shaft-3x80.ipt** as the model filename as shown.

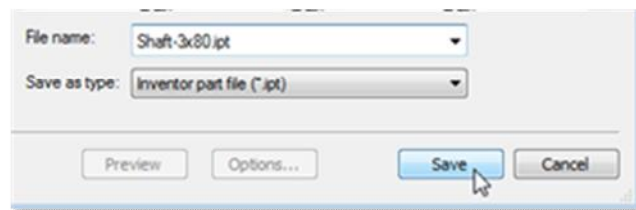

12. Click **Save** to save the model.

Note that by saving the part as a custom file, this will allow the adjustment of the length of the shaft.

13. Inside the graphics window, right-click once to bring up the option menu and select **OK** to end the Place Component command.

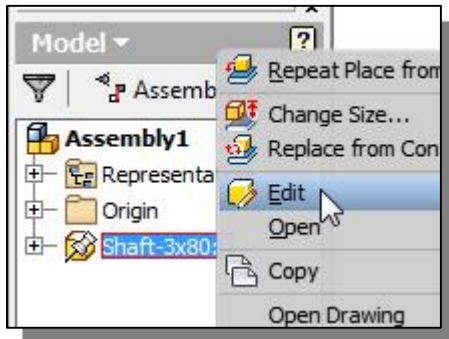

14. Inside the *browser* window, right-click once on the **Shaft-3x80** part to bring up the option menu and select **Edit** to modify the part.

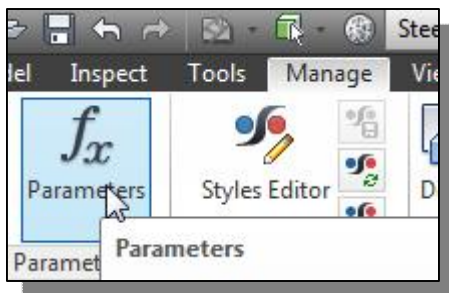

15. Click on the **Manage** tab to switch to the *Manage* toolbar.

16. Click the **Parameters** icon to bring up the *Parameters* dialog box.

User Parameters				
NND	mm	3 mm		3.0
NLG	mm	80 mm		30.
PHH	mm	0.5 mm		0.5
FAWI	deg	15		15.
DHH?	mm	DHH		0.5

17. Edit the value of the *NLG* (Nominal Length) variable to **80 mm** as shown.

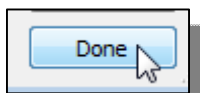

18. Click **Done** to accept the adjustment and exit the parameters dialog box.

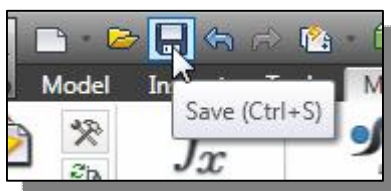

19. Click **Save** to save the changes to the model.

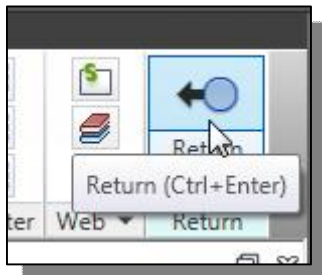

20. In the *Ribbon* toolbar area, click **Return** to end the editing of the *Shaft Model* and return to the assembly model.